

Product Type: Plug-in terminal-Socket

Product Name:MC-PE5.08V07-F-0001

Product Description: Pitch: 5.08mm Rated Voltage : 320V Rated Current: 12A colour : customizable

Product Size

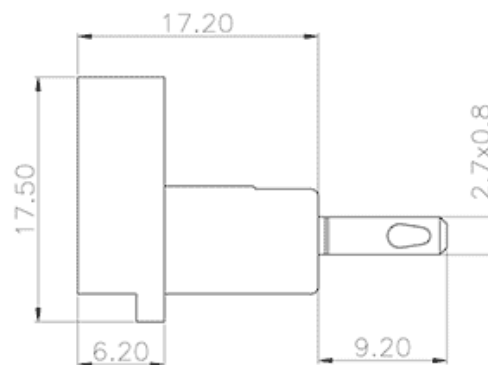
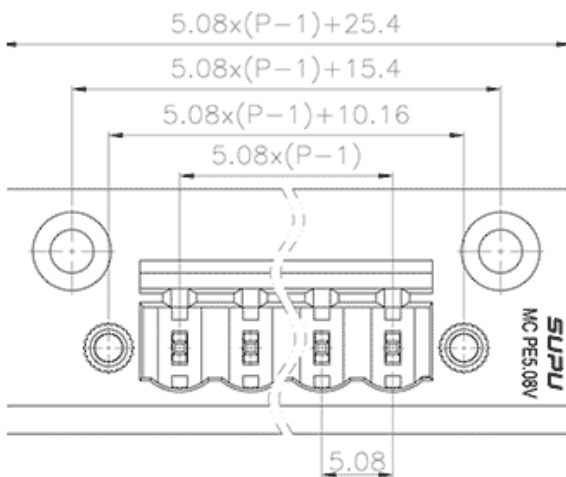

Parameters

☞ SUPU ID	MC-PE5.08V07-F-0001
☞ Pitch	5.08
☞ Number of levels	Single layer
☞ Number of connections	7

☞ Connection method	-
☞ Protection Level	IP20
☞ Operating temperature range	-40~+105°C
☞ Insulation material	PA66
☞ Insulation material group	I
☞ Contact material	Copper alloy
☞ Contact plating	Sn,Plated
☞ Color	Green/Black/Blue/Grey/Orange/Red

Technical data

☞ IEC Rated Current	320V
☞ IEC Rated Voltage	12A
☞ Overvoltage category	III III II
☞ Degree of pollution	3 2 2
☞ Rated impulse voltage	4.0KV 4.0KV 4.0KV
☞ UL Rated Current	15A - 10A
☞ UL Rated Voltage	300V - 300V
☞ Use group	B/C/D

Commercial data

☞ Order No	MC-PE5.08V07-F-0001
------------	---------------------

Ningbo SUPU Electronics Co., Ltd.

Address: No. 150, Xinxing 4th Road, High-tech Industrial Development Zone,

Cixi City, Zhejiang Province, China

Zip code: 315303

Switchboard: +86 574-63288158

Fax: +86 574-63288170

E-mail:supucontact@supu.cn

Service Hotline: 400-626-6336



Wechat

Date:2026-04-27 04:03

The right to modify data belongs to SUPU.