

Product Type: Plug-in terminal-Socket

Product Name:MC-
PQ7.62H15P-F-0001

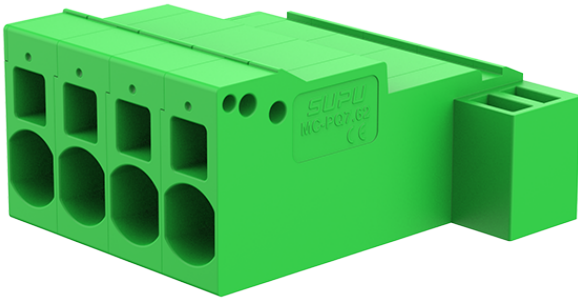

Product Description: Pitch:7.62mm Rated Voltage : 1000V Rated Current:41A Connection method : Push-in spring connection colour : colour : customizable

Product Size

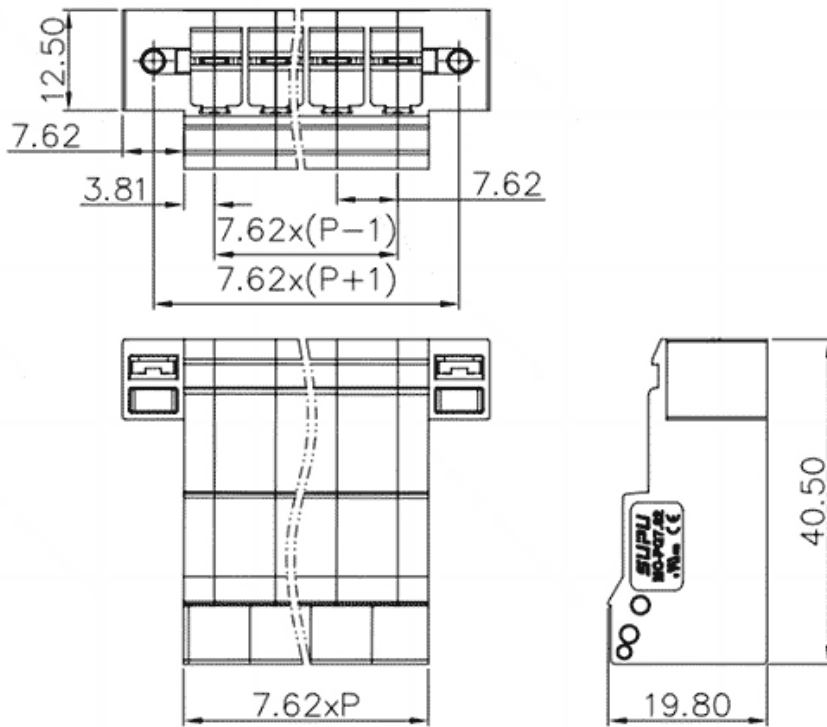

Parameters

⌘ SUPU ID	MC-PQ7.62H15P-F-0001
⌘ Pitch	7.62
⌘ Number of levels	Single layer
⌘ Number of connections	15

☞ Connection method	Push in connection
☞ Protection Level	IP20
☞ Operating temperature range	-40~+105°C
☞ Insulation material	PA66
☞ Insulation material group	I
☞ Contact material	Copper alloy
☞ Contact plating	Sn,Plated
☞ Color	Green/Black/Blue/Grey/Orange/Red

Technical data

☞ IEC Rated Current	1000V
☞ IEC Rated Voltage	41A
☞ Overvoltage category	III/III/ II
☞ Degree of pollution	3 2 2
☞ Rated impulse voltage	8.0KV 8.0KV 8.0KV
☞ UL Rated Current	35A - 35A
☞ UL Rated Voltage	600V - 600V
☞ Conductor cross section rigid	0.2~10.0mm ²
☞ Conductor cross section flexible	0.2~10.0mm ²
☞ Conductor cross section flexible,with ferrule	0.2~6.0mm ²
☞ Locking screw Specification	-
☞ Locking screw torque	-
☞ Fixed Screw Specification	-
☞ 固定螺钉扭矩	-

☞ Stripping length	13~15mm
☞ Use group	B/C/D
☞ Rated cross section	24~8AWG

Commercial data

☞ Order No	MC-PQ7.62H15P-F-0001
------------	----------------------

Ningbo SUPU Electronics Co., Ltd.

Address: No. 150, Xinxing 4th Road, High-tech Industrial Development Zone,
Cixi City, Zhejiang Province, China

Zip code: 315303

Switchboard: +86 574-63288158

Fax: +86 574-63288170

E-mail:supucontact@supu.cn

Service Hotline: 400-626-6336



Wechat