



Product Type: Heavy-duty Connector Housing

Product Name:S16A-BM-1L.M-PC

Product Description: S16A Housings,metal,1 levers,bulkhead mounting,plastic cover

Product Size

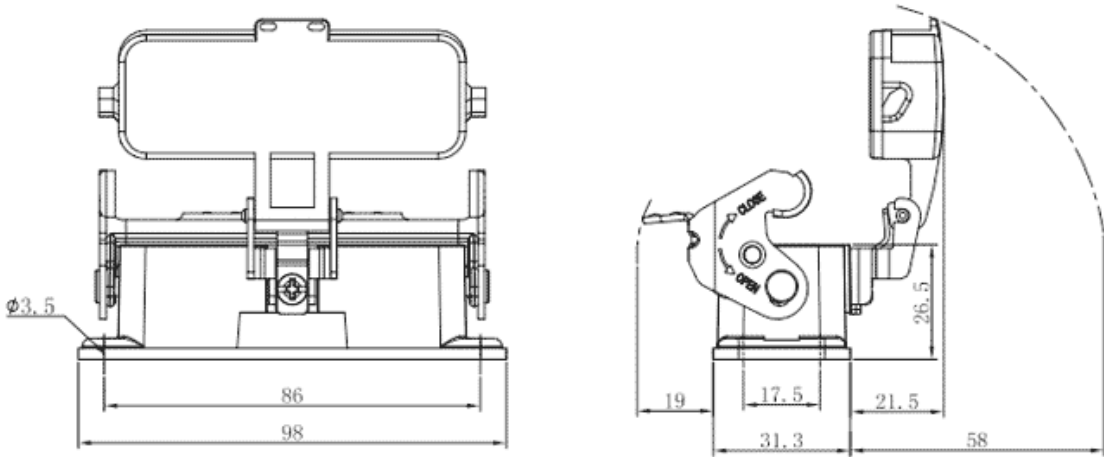

Parameters

⌘ SUPU ID	S16A-BM-1L.M-PC
⌘ Protection Level	IP65
⌘ Operating temperature range	-40°C~+125°C
⌘ Color	Grey

☞ Thread type	/
☞ Category	Base
☞ Mechanical endurance	≥500

Technical data

☞ Sealing material	NBR
☞ Housing Material	Die-Cast Aluminum

Commercial data

☞ Order No	S16A-BM-1L.M-PC
☞ Packing unit	PCS
☞ Minimum order quantity	1

Ningbo SUPU Electronics Co., Ltd.

Address: No. 150, Xinxing 4th Road, High-tech Industrial Development Zone,

Cixi City, Zhejiang Province, China

Zip code: 315303

Switchboard: +86 574-63288158

Fax: +86 574-63288170

E-mail:supucontact@supu.cn

Service Hotline: 400-626-6336



Wechat

Date:2026-05-04 14:07

The right to modify data belongs to SUPU.