

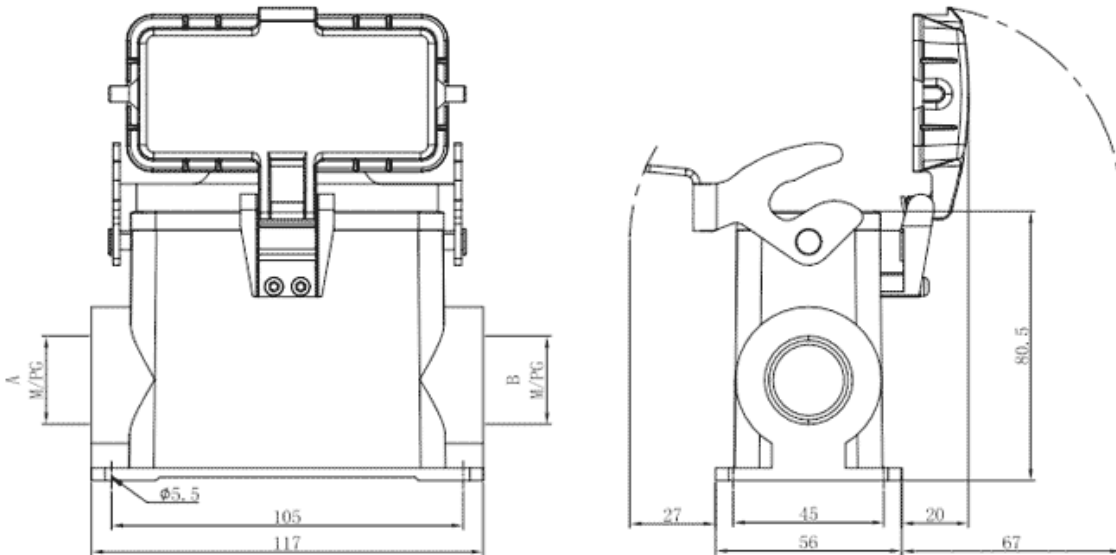

Product Type: Heavy-duty Connector Housing  
Product Name: S16B-SMH-1L.M-2PG29-MC

Product Description: S16B Housings, metal, 1 levers, surface mounting, high construction, 2xPG29 thread, metal cover

## Product Size



## Parameters

<input checked="" type="checkbox"/> SUPU ID	S16B-SMH-1L.M-2PG29-MC
<input checked="" type="checkbox"/> Protection Level	IP65
<input checked="" type="checkbox"/> Operating temperature range	-40°C~+125°C
<input checked="" type="checkbox"/> Color	Grey

<input type="checkbox"/> Thread type	PG29
<input type="checkbox"/> Category	Base
<input type="checkbox"/> Mechanical endurance	≥500

### Technical data

<input type="checkbox"/> Sealing material	NBR
<input type="checkbox"/> Housing Material	Die-Cast Aluminum

### Commercial data

<input type="checkbox"/> Order No	S16B-SMH-1L.M-2PG29-MC
<input type="checkbox"/> Packing unit	PCS
<input type="checkbox"/> Minimum order quantity	1

## Ningbo SUPU Electronics Co., Ltd.

Address: No. 150, Xinxing 4th Road, High-tech Industrial Development Zone,

Cixi City, Zhejiang Province, China

Zip code: 315303

Switchboard: +86 574-63288158

Fax: +86 574-63288170

E-mail: [supucontact@supu.cn](mailto:supucontact@supu.cn)

Service Hotline: 400-626-6336



Wechat

---

Date:2026-05-04 15:49

The right to modify data belongs to SUPU.