



Product Type: Heavy-duty Connector Housing

Product Name: S6B-CCH-1L.M-PG21

Product Description: S6B Housings, metal, 1 levers, cable to cable, high construction, PG21 thread

**Product Size**

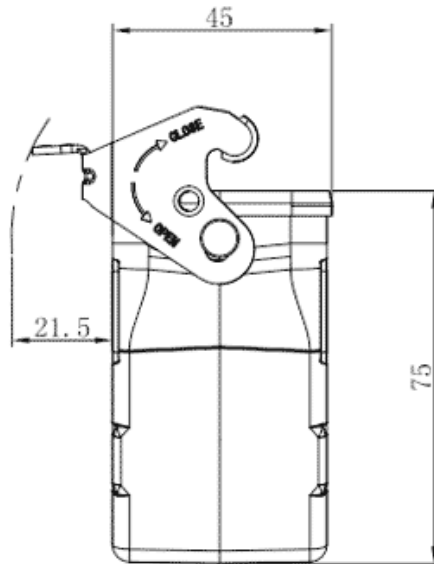
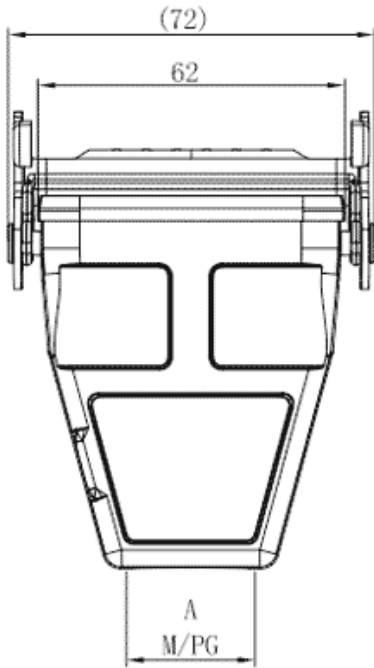

**Parameters**

|                               |                   |
|-------------------------------|-------------------|
| ☞ SUPU ID                     | S6B-CCH-1L.M-PG21 |
| ☞ Protection Level            | IP65              |
| ☞ Operating temperature range | -40°C~+125°C      |
| ☞ Color                       | Grey              |

|                        |      |
|------------------------|------|
| ☞ Thread type          | PG21 |
| ☞ Category             | Base |
| ☞ Mechanical endurance | ≥500 |

### Technical data

|                    |                   |
|--------------------|-------------------|
| ☞ Sealing material | NBR               |
| ☞ Housing Material | Die-Cast Aluminum |

### Commercial data

|                          |                   |
|--------------------------|-------------------|
| ☞ Order No               | S6B-CCH-1L.M-PG21 |
| ☞ Packing unit           | PCS               |
| ☞ Minimum order quantity | 1                 |

## Ningbo SUPU Electronics Co., Ltd.

Address: No. 150, Xinxing 4th Road, High-tech Industrial Development Zone,

Cixi City, Zhejiang Province, China

Zip code: 315303

Switchboard: +86 574-63288158

Fax: +86 574-63288170

E-mail: [supucontact@supu.cn](mailto:supucontact@supu.cn)

Service Hotline: 400-626-6336



Wechat

---

Date:2026-05-06 12:08

The right to modify data belongs to SUPU.