



Product Type: Heavy-duty connector pins

Product Name: SCGF-010-1.5

Product Description: 10A gold plated, Female, compatible with 1.5mm²

Product Size

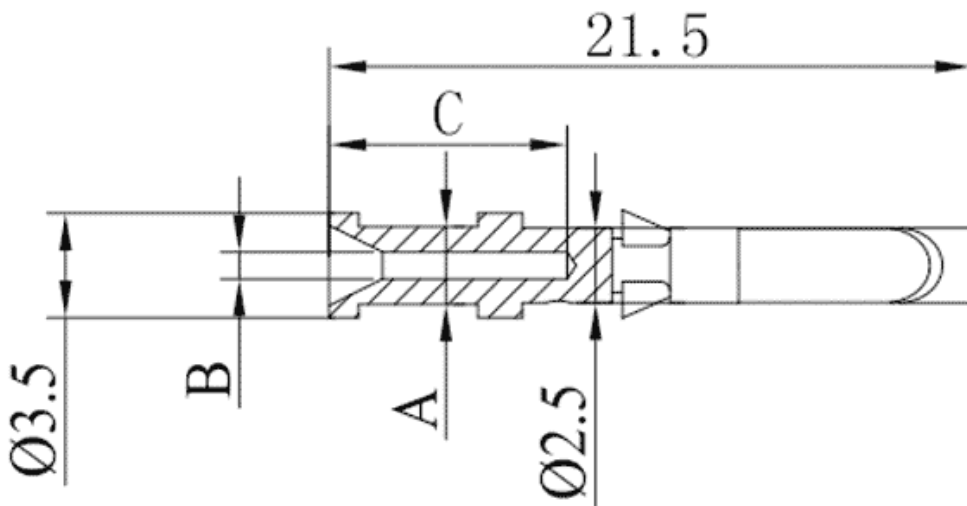

Parameters

⌘ SUPU ID	SCGF-010-1.5
⌘ Operating temperature range	-40°C~+125°C
⌘ Category	cold-pressed pin female terminal
⌘ Connection method	Crimp terminal

☞ Mechanical endurance

≥500

Technical data

☞ IEC Rated Current

10A

☞ Contact/surface material

Hard-gold Plated

☞ Pin Material

Copper Alloy

☞ Contact resistance

≤3mΩ

☞ Wire Specification

1.5mm²/16AWG

Commercial data

☞ Order No

SCGF-010-1.5

☞ Packing unit

PCS

☞ Minimum order quantity

1

Ningbo SUPU Electronics Co., Ltd.

Address: No. 150, Xinxing 4th Road, High-tech Industrial Development Zone,
Cixi City, Zhejiang Province, China

Zip code: 315303

Switchboard: +86 574-63288158

Fax: +86 574-63288170

E-mail:supucontact@supu.cn

Service Hotline: 400-626-6336



Wechat

Date:2026-05-04 16:57

The right to modify data belongs to SUPU.