



Product Type: Heavy-duty connector pins

Product Name:SCSM-005-0.52



Product Description: 5A silver plated, Male, compatible with 0.52mm²

Product Size

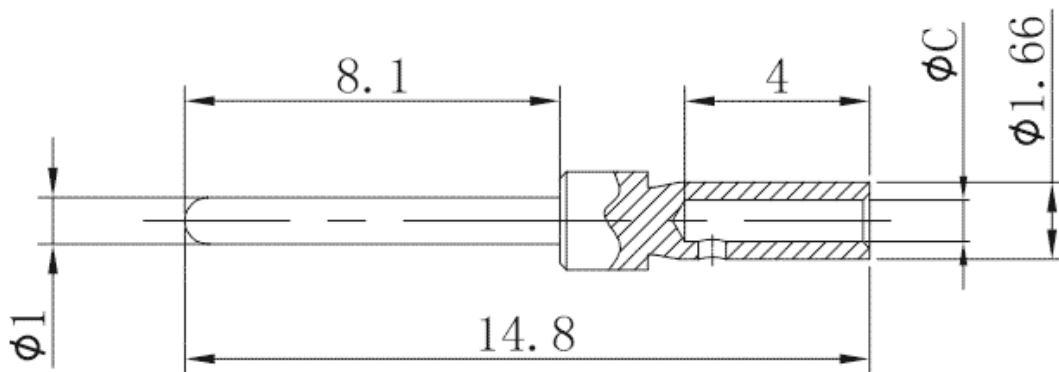

Parameters

<input checked="" type="checkbox"/> SUPU ID	SCSM-005-0.52
<input checked="" type="checkbox"/> Operating temperature range	-40°C~+125°C
<input checked="" type="checkbox"/> Category	cold-pressed pin male terminal
<input checked="" type="checkbox"/> Connection method	Crimp terminal

<input checked="" type="checkbox"/> Mechanical endurance	≥500
--	------

Technical data

<input checked="" type="checkbox"/> IEC Rated Current	5A
---	----

<input checked="" type="checkbox"/> Contact/surface material	Hard-silver Plated
--	--------------------

<input checked="" type="checkbox"/> Pin Material	Copper Alloy
--	--------------

<input checked="" type="checkbox"/> Contact resistance	≤3mΩ
--	------

<input checked="" type="checkbox"/> Wire Specification	0.33-0.52mm ² /22-20AWG
--	------------------------------------

Commercial data

<input checked="" type="checkbox"/> Order No	SCSM-005-0.52
--	---------------

<input checked="" type="checkbox"/> Packing unit	PCS
--	-----

<input checked="" type="checkbox"/> Minimum order quantity	1
--	---

Ningbo SUPU Electronics Co., Ltd.

Address: No. 150, Xinxing 4th Road, High-tech Industrial Development Zone,
Cixi City, Zhejiang Province, China

Zip code: 315303

Switchboard: +86 574-63288158

Fax: +86 574-63288170

E-mail:supucontact@supu.cn

Service Hotline: 400-626-6336



Wechat

Date:2026-05-04 17:20

The right to modify data belongs to SUPU.