



Product Type: Distributor

Product Name: M12A5M-YU-
12A5F-12A5F

Product Description: 60V AC/DC, 4A

Product Size

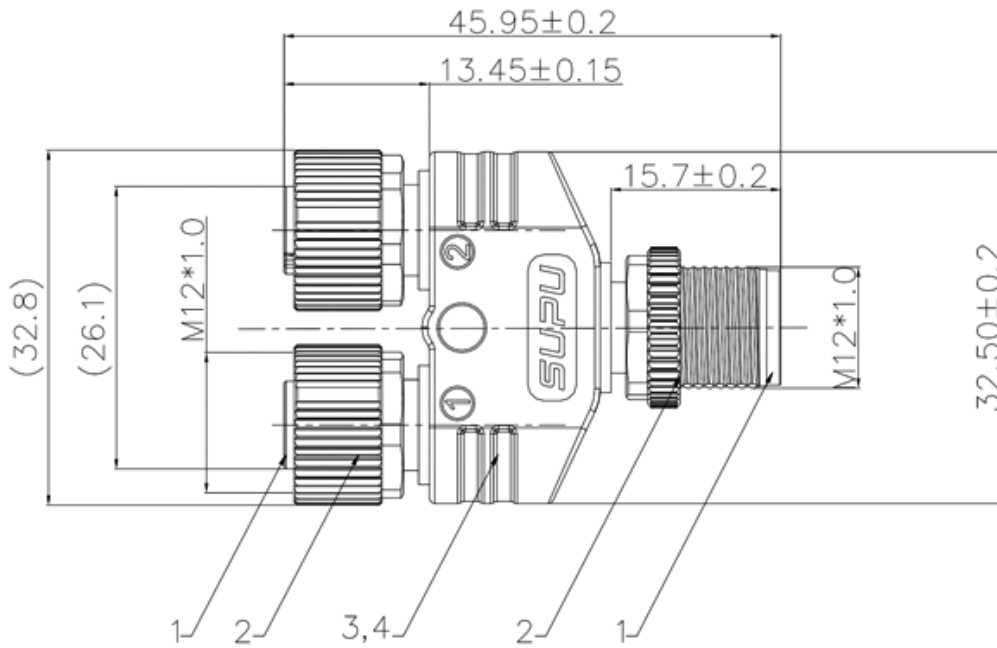

Parameters

☞ SUPU ID	M12A5M-YU-12A5F-12A5F
☞ Number of connections	5
☞ Protection Level	IP67
☞ Operating temperature range	-40~85°C

☞ Thread type	M12
☞ Category	Pin/Hole
☞ Coding	A-coding
☞ Shielded	No
☞ Mechanical endurance	≥100
☞ Standards	IEC61076-2-104

Technical data

☞ IEC Rated Current	4A
☞ IEC Rated Voltage	60V AC/DC
☞ Degree of pollution	3
☞ Insulation Resistance	≥100MΩ
☞ Contact resistance	<10mΩ
☞ Contact/surface material	CuSn/Ni/Au
☞ Contact carrier material	TPU
☞ Screw/nut material	Zinc
☞ Sealing material	NBR

Ningbo SUPU Electronics Co., Ltd.

Address: No. 150, Xinxing 4th Road, High-tech Industrial Development Zone,

Cixi City, Zhejiang Province, China

Zip code: 315303

Switchboard: +86 574-63288158

Fax: +86 574-63288170

E-mail:supucontact@supu.cn

Service Hotline: 400-626-6336



Wechat

Date:2026-04-27 16:25

The right to modify data belongs to SUPU.