



Product Type: High Current Branch Terminal

Product Name:SPDB35-16-8×16

Product Description: Connection method:Screw connection,IEC Rated Current:125A,IEC Rated Voltage:690V,Number of connections:10

Product Size

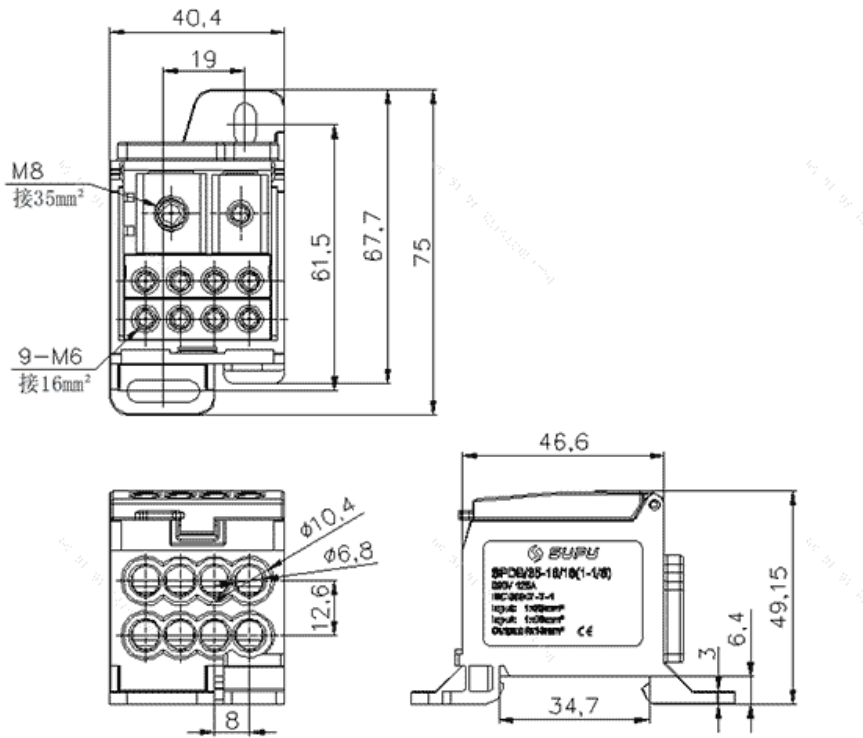

Parameters

⌘ SUPU ID	SPDB35-16-8x16
⌘ Width	40.4mm
⌘ Number of connections	10
⌘ Connection method	Screw connection

☞ Protection Level	IP20
☞ Insulation material	PA66
☞ Insulation material group	I
☞ Contact material	Copper alloy
☞ Contact plating	Sn,Plated
☞ Ambient temperature (operation)	-40°C~105°C
☞ Ambient temperature (assembly)	-5°C~70°C
☞ Ambient temperature (storage)	-25°C~60°C
☞ Permissible humidity (storage/transport)	30%~70%

Technical data

☞ IEC Rated Current	125A
☞ IEC Rated Voltage	690V
☞ Degree of pollution	3
☞ Rated impulse voltage	2.5KV
☞ Locking screw Specification	M6/M8
☞ Locking screw torque	3N·m/5N·m
☞ Stripping length	9-12mm/10-12mm/14-15mm
☞ Connection capacity AWG	2.5-16mm ² /6-16mm ² /10-35mm ²
☞ 短路电流 (峰值)	30
☞ 短路电流>1S	4.2

Commercial data

☞ Order No	SPDB35-16-8x16
------------	----------------

Ningbo SUPU Electronics Co., Ltd.

Address: No. 150, Xinxing 4th Road, High-tech Industrial Development Zone,
Cixi City, Zhejiang Province, China

Zip code: 315303

Switchboard: +86 574-63288158

Fax: +86 574-63288170

E-mail:supucontact@supu.cn

Service Hotline: 400-626-6336



Wechat

Date:2026-04-26 15:23

The right to modify data belongs to SUPU.