

Product Type: IP67 connector

Product Name:ESF-RS250A70YB3

Product Description: Connectors suitable for energy storage modules: Color: Orange Wire cross-section: 50 mm² to 70 mm² Rated voltage: 1500V DC Rated current: 250A Connection method: screw Contact type: Pin

Product Size

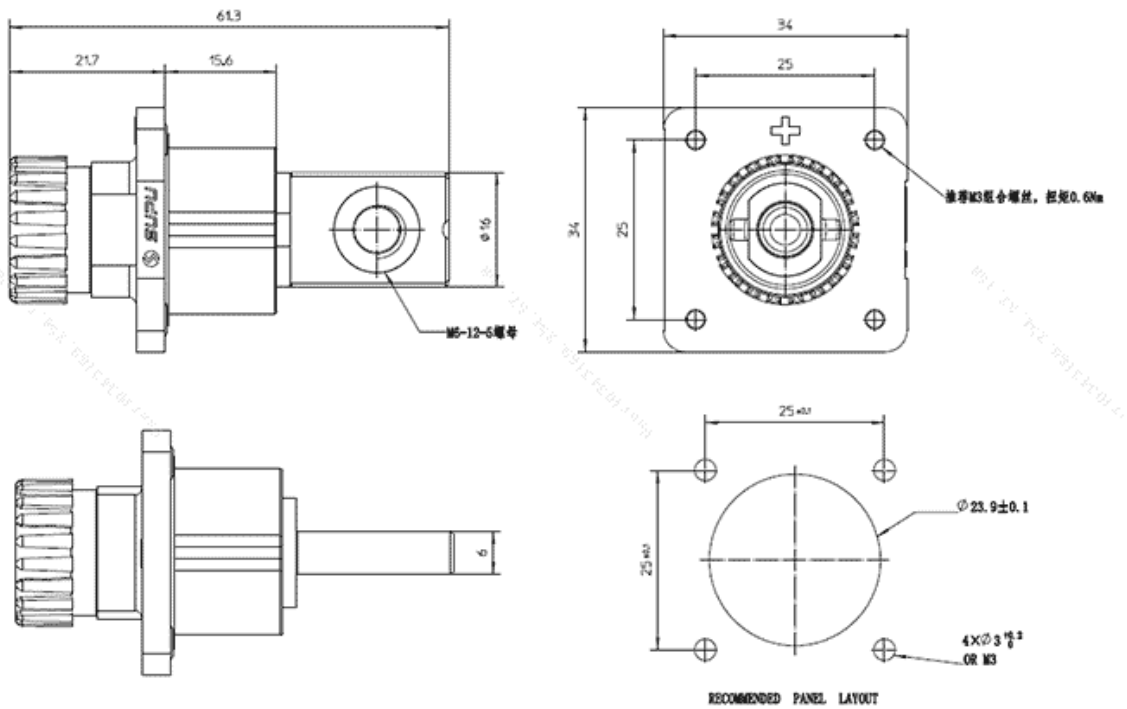

Parameters

☞ SUPU ID	ESF-RS250A70YB3
☞ Number of connections	1
☞ Connection method	Screw thread

☞ Protection Level	IP 67
☞ Operating temperature range	-40°C~+125°C
☞ Insulation material	PA
☞ Insulation material group	III
☞ Contact material	Copper alloy
☞ Contact plating	Ag,Plated
☞ Insertion/withdrawal cycles	100
☞ Insertion force	≤75N
☞ Withdrawal force	≥10N

Technical data

☞ IEC Rated Current	250A
☞ IEC Rated Voltage	1500V DC
☞ Overvoltage category	III
☞ Degree of pollution	3
☞ Rated impulse voltage	12.3KV
☞ UL Rated Current	250A
☞ UL Rated Voltage	1500V DC
☞ Stripping length	/
☞ Rated cross section(AWG)	2/0 AWG
☞ External cable diameter	/

Commercial data

☞ Order No	ESF-RS250A70YB3
------------	-----------------

☞ Packing unit	Pcs
☞ Minimum order quantity	1
☞ Single piece weight	53g

Ningbo SUPU Electronics Co., Ltd.

Address: No. 150, Xinxing 4th Road, High-tech Industrial Development Zone,
Cixi City, Zhejiang Province, China

Zip code: 315303

Switchboard: +86 574-63288158

Fax: +86 574-63288170

E-mail:supucontact@supu.cn

Service Hotline: 400-626-6336



Wechat